



In partnership with



OUTDOOR WIRELESS PTZ DOME CAMERA SOLUTION

WIR-686C Camera WAVE Base Station

IP PTZ dual stream camera featuring 36x optical zoom and an integrated wireless link optimised for high quality, low latency video. Solution options enable effective video transmission over distances of up to 2, 5 and 20Km.

Outdoor Wireless IP PTZ Dome Camera Solution Featuring a High Quality, Low Latency Video Wireless Link Operating Up To 20Km



Up to 4 x WIR-686C Cameras can communicate over a range of up to 20Km with a standard Wavesight base unit, providing up to 30fps, MPEG-4, 640x480 resolution video*



In partnership with Wavesight, Europe's leading innovator in wireless CCTV and transmission solutions comes a high specification PTZ dome camera featuring a fully integrated, high specification wireless link.

Capable of transmitting high quality video up to 20Km and featuring exceptionally low latency, the WIR-686C eliminates the need for costly leased lines or cable installation.



Wireless Connectivity

Wavesight, Europe's leading innovator in professional, video optimised wireless transmission technologies has partnered with JVC Professional Surveillance to deliver the industry benchmark Outdoor Wireless enabled PTZ network dome camera

Faster Deployment

By integrating a wireless communications system within a CCTV camera, this fast deployment solution eliminates the cost, delays and disruption associated with cable installation

High Level Video Security

Featuring a range of advanced encryption technologies - The WIR-686C integrated camera solution is compact but not compromised

WavePULSE Pro-active Monitoring

Available as an option and utilising resilient GPRS wireless infrastructure, WavePULSE is an independent gateway to Wavesight deployed radio architecture and enables remote configuration and monitoring of the wireless link

MPEG-4/Motion JPEG Full-Frame Dual Stream

Simultaneous distribution of MPEG-4 and Motion JPEG VGA images at full frame rate (30fps for each stream)

0.03° Super Accuracy for Preset Positions

Direct Drive Mechanism maintains accurate camera positioning even at 36x magnification

0.04°/sec to 400°/sec Pan Speed Flexibility

Direct Drive Mechanism enables both quick position changes by high-speed panning and detailed monitoring by slow panning

Progressive Output Capability

Can output clear, smooth images without flicker even for moving objects

Super LoLux TM Sensitivity

0.04 lx at B&W mode (25 % video level, F1.6, AGC SUPER)
0.5 lx at color mode (25 % video level, F1.6, AGC SUPER)

* Subject to site survey, antenna selection and positioning.
Operating range dependant upon camera option and base station system used:
WaveSPRINT - Up to 2Km (single camera link)
WaveFLOW - Up to 5Km (up to 4 camera links)
WaveMAX - Up to 20Km (up to 4 camera links)

Fully Integrated PTZ Dome Camera and High Quality Video Wireless Link

In partnership with Wavesight, Europe's leading innovator in wireless CCTV and transmission solutions comes a high specification PTZ dome camera featuring a fully integrated, high specification wireless link.

Class-leading performance

Offering class-leading performance in a single package, a high specification PTZ dome camera with an integrated wireless video transmitter optimised for use at distances of up to 20Km.

Faster deployment, reduced environmental impact

By integrating a wireless communications system within a CCTV camera, Wavesight's fast deployment solution eliminates the cost, delays and disruption associated with cable installation. The system is ideal for short term covert surveillance use and application around aesthetically sensitive areas and buildings of historical importance, eliminating the need to run unsightly cables and minimising drilling into architecturally important structures. The system features a standard N-type connector for the connection of a variety of external antenna options.

24/7 all weather reliability

The system meets IP66 specification for water and dust protection and meets all criteria for external use - delivering the resilience and reliability, whatever the weather conditions.

High level video data security

Wavesight wireless communications offer high levels of data security. With 128 Bit AES, 154 Bit WEP plus TKIP and SPG1- Wavesight's own unique packet compression technology - Wavesight's integrated camera solution is compact but not compromised.

WavePULSE pro-active monitoring

WavePULSE* is a secure, independent gateway to Wavesight deployed radio architecture. Utilising resilient GPRS wireless infrastructure and operating independently of the video transmission link, WavePULSE enables monitoring of wireless link quality of service amongst other features including:

- Remote system configuration
- Wireless link activity monitoring
- Remote firmware updates

* Available as an option, software licence required

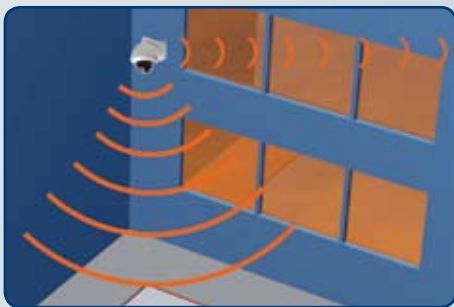

Police surveillance

Rapid deployment using a single integrated camera and wireless communications system enables the effective surveillance of specific targets on a temporary basis.



Car park security

Eliminate the time, cost and public inconvenience associated with civil engineering work to install cable connections between cameras and the CCTV control point.

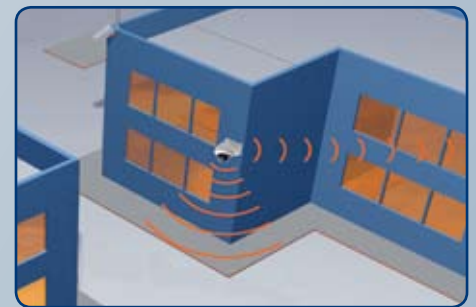

Town centre surveillance

Provide a flexible and convenient method of creating a wireless video link between town centre camera installations and a CCTV control room.

Base Station

WaveSPRINT

Supports a point-point wireless link with a single WIR-686C-02 camera unit over distances up to 2km.



Camera

WIR-686C-02

Wireless camera unit suitable for use with a WaveSPRINT/FLOW/MAX Base Station over distances up to 2Km.

WaveFLOW

Supports a point-point or multipoint wireless link with up to 4 camera units over distances of up to 2km (WIR-686C-02) or up to 5km (WIR-686C-05).



WIR-686C-05

Up to 4 x WIR-686C-05 wireless camera units can be used in a point-multipoint configuration with a WaveFLOW/MAX Base Station over distances up to 5Km.

WaveMAX

Supports a point-point or multipoint wireless link with up to 4 camera units over distances of up to 2km (WIR-686C-02), up to 5km (WIR-686C-05) or up to 20Km (WIR-686C-20).



WIR-686C-20

Up to 4 x WIR-686C-20 wireless camera units can be used in a point-multipoint configuration with a WaveMAX Base Station over distances up to 20Km.

Silent and Accurate Operation for Reliable Monitoring

Instead of a conventional belt-type mechanism, the Direct Drive Motor can greatly increase accuracy and decreasing operation noise. With an accuracy of 0.03°, it can precisely maintain preset camera positions even after frequent panning and tilting, which becomes especially important at high zoom magnifications like 36x.

■ Conventional belt-type unit with low accuracy

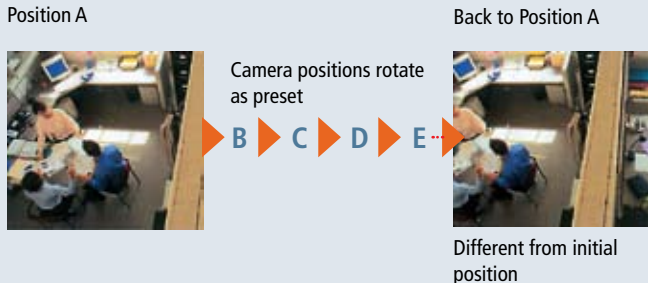

■ WIR-686C Direct Drive Motor with 0.03° accuracy

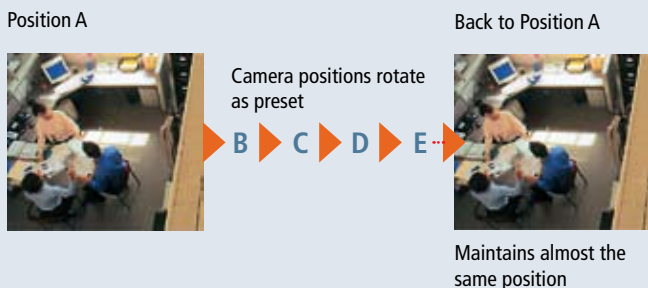

MPEG-4/Motion JPEG Full-Frame Dual Stream

The WIR-686C can stream both MPEG-4 and Motion JPEG VGA images simultaneously at the full frame rate (30fps for each stream). MPEG-4 distribution is ideal where monitoring with smooth, high frame rate images is required within a limited bandwidth. Motion JPEG images are useful when you need to record images as evidence data, because of the high quality still pictures it can provide.

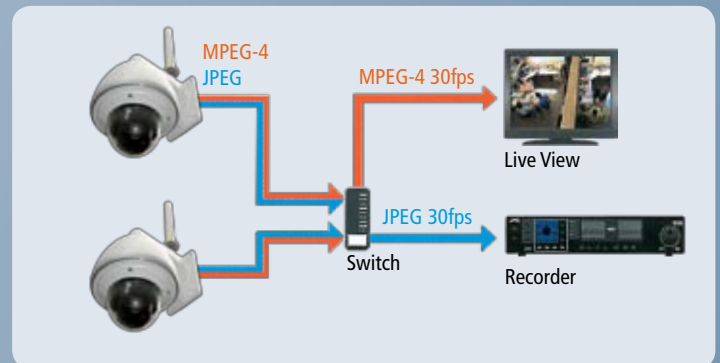

Progressive Output for Clearer Images

The WIR-686C series progressive output images are optimal for monitoring on LCD or TFT monitors. You can obtain flicker-free noiseless images even for moving objects.



Full-featured intelligent security camera for a variety of environments

■ Easy Wide-D Function for backlight compensation

This function is equivalent to the conventional Wide Dynamic Range function, allowing pictures to be adjusted to identify details of the subject even in difficult backlit conditions.



■ IR Cut filter ON/OFF function for round-the-clock surveillance

The IR cut filter automatically switches between ON and OFF according to the level of ambient light. In daytime it outputs a high-quality colour image, and at night the filter mechanism removes the IR filter to output black-and-white images with greater sensitivity. When utilizing IR lamps, an external trigger for night mode is recommended.

■ Privacy mask for protecting against intrusive monitoring

Up to 8 masked areas can be set as hidden areas to protect subjects from invasion of their privacy.

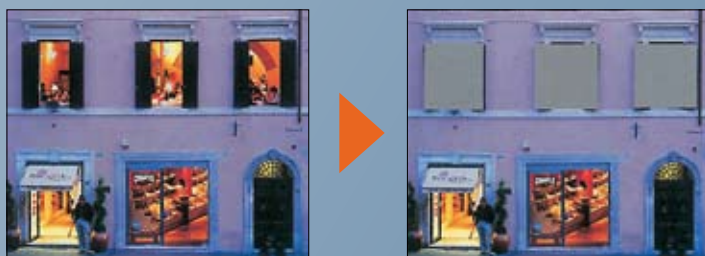

■ Open architecture API for easy customisation

The WIR-686C employs the open architecture API (Application Program Interface) which allows higher flexibility with simple command system and HTTP-based protocol. Various settings and customisation are possible via network.

■ Display mode for CRT and LCD

By choosing the display mode that matches the monitor being used, you'll get images with optimal brightness regardless of whether you are using a CRT or LCD monitor.

■ Image Stabiliser to correct image blur

Even in cases where the camera is shook by the wind or vibrations coming from its surroundings, the Image Stabilizer function helps reduce image blur. This function is invaluable in outdoor setups, such as Pendant mount style installations which are especially susceptible to the effects of vibrations.

■ Motion Detect and Tracking function

This function outputs an alarm whenever movement is detected within a pre-specified area of the image. It can also be used to automatically track a moving object or person for about 30 seconds. (The red frame of the detected subject is shown only in Demonstration Mode.)



■ Proven reliability with JVC standard

JVC inspects every single product based on our strict quality standards. You can count on its precision and durability against long-term usage. Camera model has been designed to endure 2 million times of zooming and 4 million times of focusing*. Severe tests against water and dust are applied to ensure stable performance that conforms to the IP66 Standard.

* Numbers are guides and may vary depending on the usage conditions.

Images are explanatory purposes and are not actual images attained using this product.

■ Specifications

CAMERA SPECIFICATION		
Camera type	Outdoor PTZ Network Dome Camera	
Image device	1/4" IT CCD	
Lens	F1.6 (wide) to F4.5 (tele) f=3.4mm to f=122mm Automatic Day/Night IR cut filter Focus: Manual/Easy AF/One push Max. close-range: Approx. 1.8m (tele), 0.6m (wide)	
Zoom	36x optical and 32x digital, total 1152x	
Minimum illumination	Colour	1.0 lx (F1.6, 50% video, AGC SUPER) 0.5 lx (F1.6, 25% video, AGC SUPER)
	B&W	0.08 lx (F1.6, 50% video, AGC SUPER) 0.04 lx (F1.6, 25% video, AGC SUPER)
Pan/Tilt range	Pan: 360° endless / Tilt: -5° to 185°	
Pan/Tilt speed	0.04°/sec to 400°/sec	
Picture compression	Motion JPEG: Variable (VFS)/Average (AFS) selectable MPEG-4: Part 2 (ISO/IEC 1449602) CBR/VBR selectable, Profile: SP	
Picture resolution	640 x 480, 320 x 240	
Frame rate and streaming	Up to 30fps per each stream of Motion JPEG and MPEG-4 in 640x480 resolution simultaneously (Full frame dual stream)	
Image settings	Compression levels: VFS 7 steps, AFS 10KB-100KB (Motion JPEG)/ Bit rate adjustable (MPEG-4) Image stabilizer Monitor type Other settings: AGC, BLC, White level, Black level, Gamma, Enhance, Color level, Shutter speed, Day/Night Overlay capabilities: Time, Date, Text (Camera ID, Preset title), Privacy mask (8 areas), Motion Detection	
PTZ function	100 preset positions, Auto flip, Auto pan, Auto trace, Auto patrol, Auto return, Motion detect, Auto tracking	
Security	3 levels password, IP address filtering, HTTPS encryption (for setting)	
Shutter speed	2 sec to 1/10000 sec	
Max. clients	20 simultaneous users, Unlimited users by multicast	
Alarm & event management	Events triggered by built-in motion detection, external inputs or according to schedule. Image upload over FTP, e-mail Notification over TCP, UDP, e-mail and external outputs Pre-and post alarm buffer of up to 8MB (approx. 2min. of 640x480 at 3 fps/JPEG stream)	
WIRELESS LINK SPECIFICATION		
Antenna	External N-type antenna connection for use with a wide range of antenna options	
Ethernet interface	10/100 BaseT Auto Sensing, All ports screened	
Wireless network interface	5GHz: IEEE 802.11 (a) Band B,C OFDM	
Data rate	IEEE 802.11 (a) 54, 48, 36, 24, 18, 12, 9, 6 5GHz Band B,C	
Security	WEP 64/128/152, WEP 2, WPA, TKIP, 128 Bit AES, Access Control, SSID Suppress IEEE 802.1 x / EAP, 802.1x Radius Client Support	
Management Tools	RFAlyser software suite Real Time device monitoring. Automatic software updates facility. Full real time configuration. Diagnostic support and data logging. SNMP MIB II WavePULSE monitoring software suite (option / additional licence required)	
Approvals	ETSI 300 328, ETSI 300 826, FCC Part 15	
GENERAL SPECIFICATION		
Dust & Water Protection	IP66	
Operating Temperature	-40°C to 50°C, power always on (0°C to 40°C recommended)	
Dimensions	Diameter 260mm (incl. housing) x 385mm (H: incl. bracket) x 350mm (D: incl. bracket)	
Weight	5.5kg	

■ Dimensions

Camera (mm)

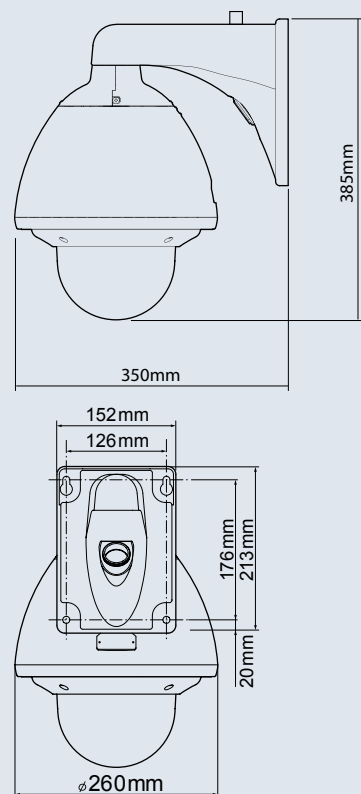

Camera Wireless Control Unit (mm)

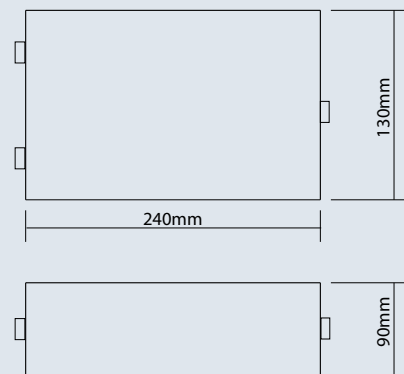

wavesight

A Jaltex Group Company

In partnership with

JVC
The Perfect Experience

Wavesight Limited

Unit 13, Dencora Way, Sundon Business Park, Luton, Beds, LU3 3HP, UK
T +44 (0)1582 578160, F +44 (0)1582 578298, E sales@wavesight.com
www.wavesight.com

Copyright © 2009, Wavesight, Limited, All Rights Reserved. Design and specifications subject to change without notice.

When used in the UK, privately operated radio equipment in Band C must take into consideration the location of the primary users and be licensed with OFCOM. Details of licensing and the locations of 5Ghz equipment can be found at: <http://www.ofcom.org.uk/radiocomms/ifi/licensing/classes/rans/information>

Copyright © Wavesight. All rights reserved. All other company and product names maybe trademarks of their respective companies. While every effort is made to make sure the information shown is accurate, Wavesight does not accept any liability for any errors or mistakes that may arise. Specifications and other information may be subject to change without notice. All performance figures and other data contained in this document may vary by application.

JVC Professional Europe Limited

JVC House, JVC Business Park, 12 Priestley Way, London, NW2 7BA, UK
T +44 (0) 20 8208 6200, F +44 (0) 20 8208 6260, E sales@jvcpro.co.uk
www.jvcpro.co.uk

Copyright © 2009, Victor Company of Japan, Limited, All Rights Reserved Design and specifications subject to change without notice.

"JVC" is the trademark or registered trademark of Victor Company of Japan Limited.